



# PS-450i User Manual



# Table of Contents

Safety Notice .....	3
Introduction to PS-450i .....	6
Infotrace System Overview .....	7
Wiring Diagram .....	10
Warranty Information .....	12



# Safety Notice

## SAVE THESE INSTRUCTIONS READ AND FOLLOW ALL INSTRUCTIONS

This manual gives step-by-step instructions for the preparation, setup, and operation of the PS-450i power supply.

There is a potential risk of fire, electric shock, or injury to persons if the product is not used as instructed.

The PS 450i should be used in an indoor environment only.

### **WARNING: Use basic precautions, including:**

- Read this manual before connecting power.
- Use supervision around children.
- Do not touch moving parts.
- Only use attachments recommended or sold by Wybron.
- Use in a dry location only.

### **Safety Standards**

Wybron PS-450i complies with the USL Standard for Stage and Studio Luminaire and Connector Strips, UL 1573.

Wybron PS-450i complies with the CNL Standard for Stage and Studio Luminaries, CAN/CSA C22.2 No. 166-M1983.

### **Product Modification Warning**

Wybron, Inc. products are designed and manufactured to meet the requirements of United States and international safety standards. Modifications to the products could affect safety and render the product non-compliant to relevant safety standards.

## Notes de Sécurité

### EPARGNER CES INSTRUCTIONS LIRE ET SUIVRE TOUTES NOTES DE SÉCURITÉ

- ❖ Ce manuel donne des instructions pour la préparation, l'organisation, et l'opération du NexeraLX Luminaire.
- ❖ Il y a un risqué de feu, décharge électrique, ou la blessure aux gens si le produit n'est pas utilisé comme instruit.
- ❖ Le NexeraLX Luminaire va être utilisé à la maison seulement et pas pour l'usage résidentiel.

### L'Avertissement de Modification de Produit

Les produits de Wybron, Inc. sont conçus et a fabriqué pour rencontrer les conditions d'Etats-Unis et de norms de sûreté internationaux. Les modifications aux produits pourraient affecter la sûreté et rendent le produit non-conciliant aux normes de sûreté pertinentes.

### Les Instructions Importantes de Sûreté

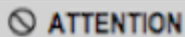

***Ce produit est pour l'usage professionnel seulement.  
Ce n'est pas pour l'usage résidentiel.***

**Lire ce manuel avant d'alimenter ou l'installation de l'accessoire.** Suivre les précautions de sûreté et observer tous avertissements dans ce manuel et sur l'accessoire. Si vous avez des questions sur la manière de fonctionner l'accessoire sans accident, s'il vous plaît contacter votre négociant de Wybron ou Wybron d'appel directement à 1-800-624-0146.

### Pour vous protéger et les autres de la décharge électrique :

LES AVANCES PRINCIPAUX SONT CONFORMEMENT COLORES AU CODE SUIVANT ET DOIVENT ETRE CONNECTES DANS L'ARRANGEMENT SUIVANT :

UNITES DE TUNGSTENE (Modèles #2560, #2570, #2640):

- vert et jaune – terre Ⓡ
- bronzage – neutre
- bronzage – ligne

UNITES DE CDM (Modèles #2580, #2600, #2650):

- vert et jaune – terre Ⓡ
- bleu – neutre
- marron – ligne

L'AVERTISSEMENT – CET EQUIPEMENT DOIT ETRE FONDE.

# Aviso Sobre Seguridad

## SALVE ESTAS INSTRUCCIONES LEA Y SIGA TODAS INSTRUCCIONES

Hay un riesgo potencial del fuego, el calambre o la herida a personas si el producto no se utiliza como instruido.

ADVERTENCIA: Cuando se usa electrodomésticos, el uso las precauciones básicas, incluyendo:

- Lea este manual antes de accionar o instalar la instalación fija.
- Supervise a niños cercano.
- Seque ubicación sólo.

La PS fuente del poder deberá ser utilizado en un ambiente interior sólo y no es pensado para el uso residencial.

Para la protección continuada contra el riesgo del fuego, reemplaza sólo con mismo tipo y calificación de fusible.

La Protección contra calambre se asegura sólo si el conjunto conectado principal de cuerda es conectado a un apropiadamente earthed que muele receptáculo de tipo.

Una toda asta desconecta dispositivo se debe localizar adyacente a la unidad o, si la cuerda de C.A. se utiliza como el principal desconecta dispositivo, asegure que la enchufe-salida localiza/instalado cerca del equipo y sea fácilmente accesible

EL PRINCIPAL DIRIGE SON COLORADOS DE ACUERDO CON EL CÓDIGO SIGUIENTE Y se DEBE CONECTAR EN EL ESQUEMA SIGUIENTE:

- verde y amarillo – molió/la tierra 
- azul – neutral
- brown – línea

La ADVERTENCIA – ESTE EQUIPO DEBE SER EARTHED.

Para preguntas, el contacto Wybron en 1-800-624-0146 o visita [www.wybron.com](http://www.wybron.com).

### Advertencia de Modificación de Producto

Wybron, los productos S.a. se diseñan y son fabricados para encontrar los requisitos de Estados Unidos y estándares Internacionales de seguridad. Las modificaciones a los productos podrían afectar la seguridad y rendir el producto no conformista a estándares pertinentes de seguridad.

## **Introduction to PS-450i**

The PS-450i is Wybron's wall mount power supply. The PS-450i works with devices that use the industry-standard two-way communication protocol Remote Device Management and other RDM-compatible devices via one or more DMX channels on a lighting console.

The power supply passes the DMX512 signal from the lighting console and sends it to each device alongside 24 volts DC. The DMX signal can then continue on to other DMX-controlled devices or more power supplies. Because it sends both power and DMX signal on a single cable, the PS-450i eliminates the need for a separate power cable for each attached device.

The RDM-compatible PS-450i works alongside Wybron's Infotrace Control and Management System, which uses RDM to send feedback from lighting equipment to the operator's computer or iPhone.

# Infotrace System Overview



*Figure 1 – Infotrace System Components*

The diagram above outlines the key components, which include:

**Infotrace:** The entire system

**Infogate:** The software and hardware (Infogate box) necessary to collect, transfer, and display the feedback.

**Infochip:** A conversion chip that can be installed into non-RDM equipment, allowing it to communicate with Infogate.

**Infostore:** An Internet-based application that collects the data captured by Infogate and sorts it for historical reflection.



## How the Infotrace System works

Infotrace is a two-way DMX / RDM communication and management system.

The heart of the Infotrace system is Infogate — specialized hardware and software that uses RDM to communicate with potentially every piece of equipment mounted on a lighting rig.

RDM packets are interleaved with DMX-512 data packets. These RDM command / response packets allow configuration, control, interrogation, and response.

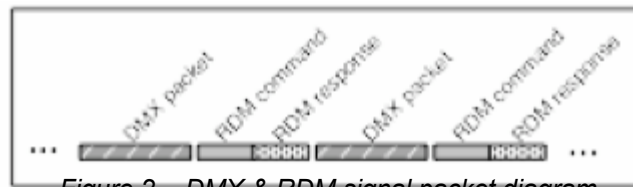

Figure 2 - DMX & RDM signal packet diagram

The DMX-512 packets control the lighting equipment in the usual manner. The RDM commands originate at the controller – Infogate. The RDM responses are returned to Infogate from Wybron IT devices (such as Coloram IT) and other RDM devices.

In addition, any non-RDM equipment can be upgraded with the installation of an Infochip. Because Infogate can work with any equipment, the setup, unit testing, and troubleshooting for an entire rig can be coordinated from a single laptop.

Wybron's IT equipment (Coloram IT, CXI IT, Eclipse IT, and Eclipse II IT) is equipped with a series of sensors that can relay a wealth of information to Infogate. These sensors can detect everything from light, voltage, and current to fan speed and even gelstring frame color information.

# Infotrace System Connection Diagram

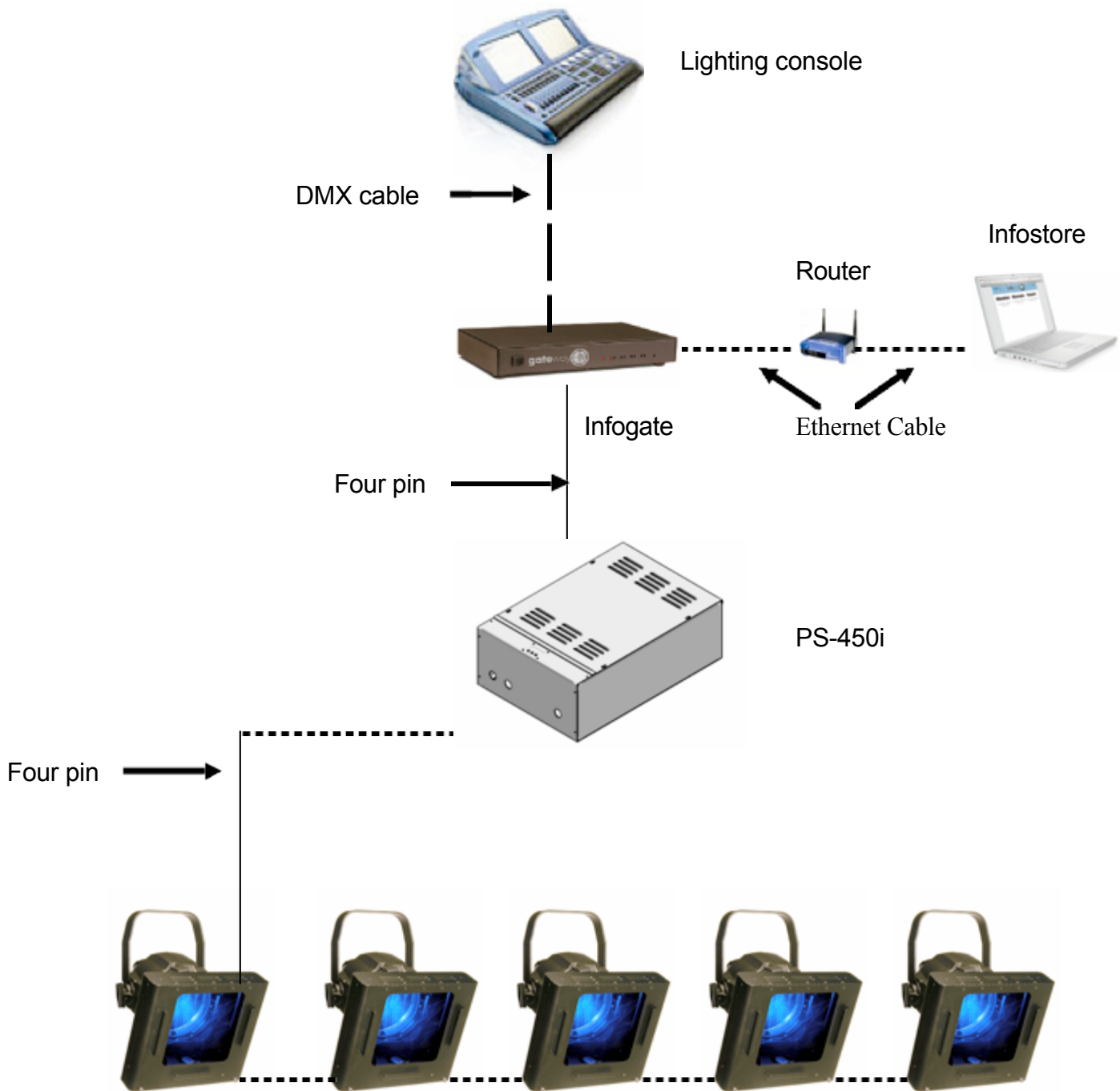

# PS-450i Wiring Diagram

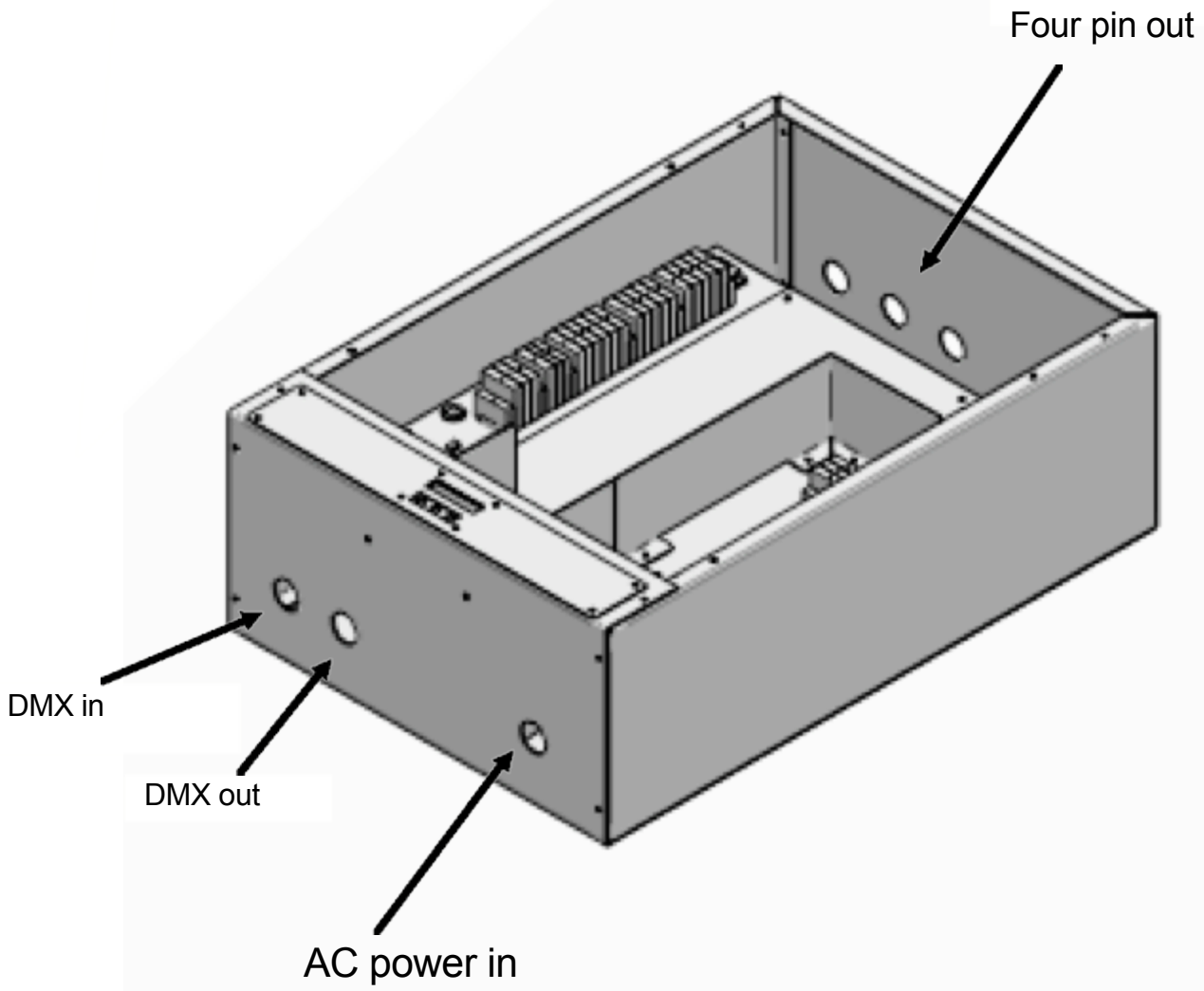

# Wiring Diagram

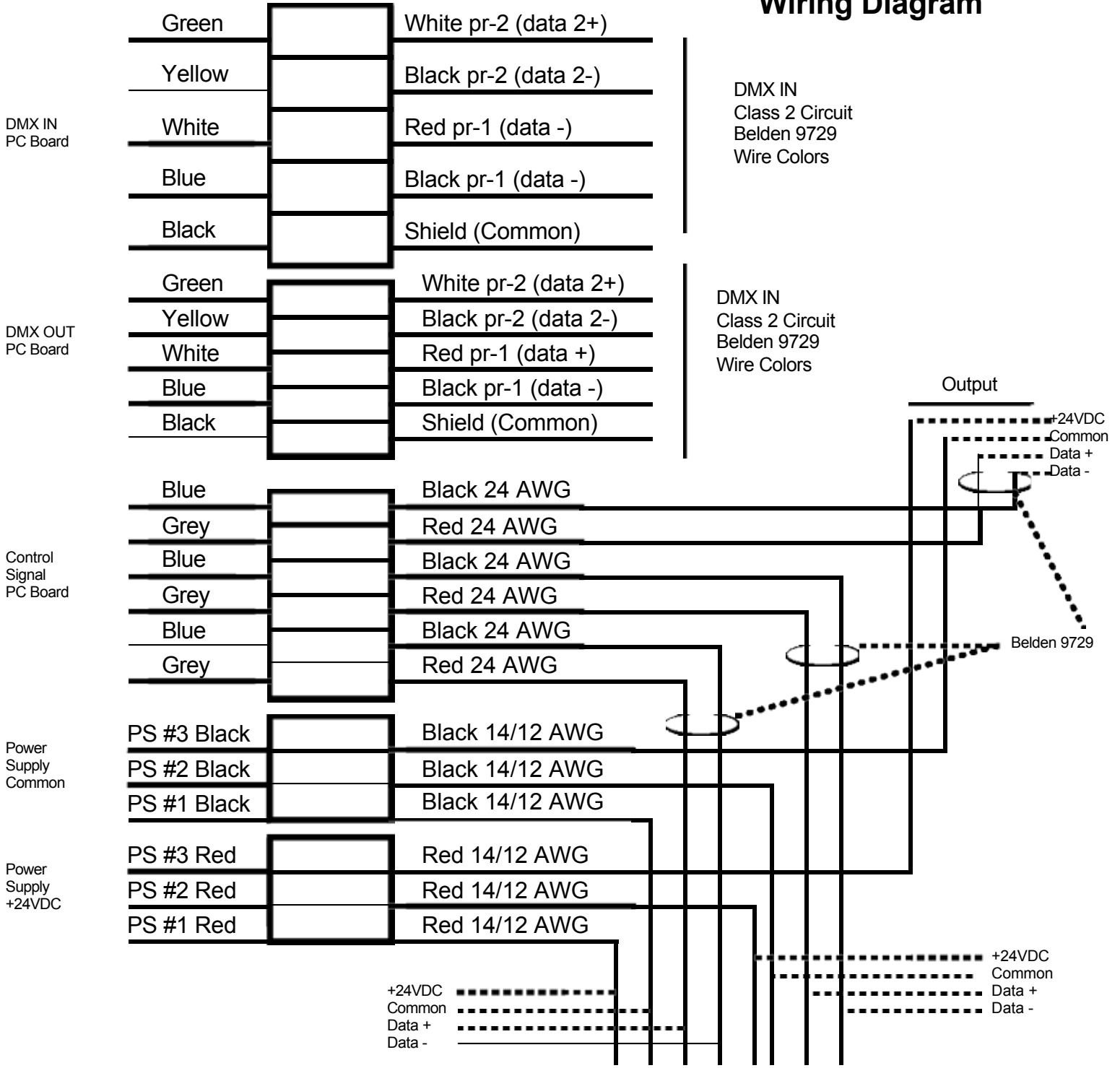

Power/data cable uses four pin

XLR Pin #	Wire Color	Function	Size
1	White	Ground	14 AWG
2	Green	Data -	22 AWG
3	Red	Data +	22 AWG
4	Black	24 Volts DC	14 AWG

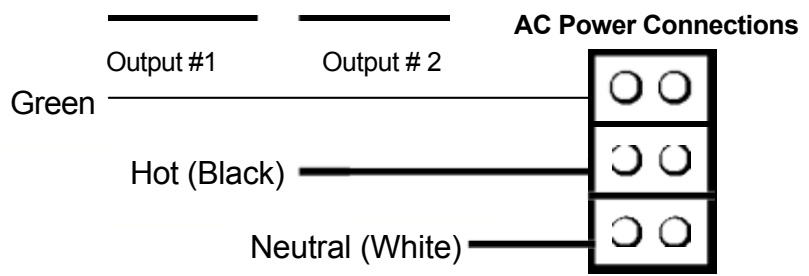

## Warranty Information

WYBRON, INC. warrants to the original owner or retail customer that for a period of one year from date of delivery of a portable system or energization of a permanently installed system (up to a maximum of 18 months from delivery) its products will be free from defects in materials and workmanship under normal use and service.

Warranty does not cover any product or part of a product subject to accident, negligence, alteration, abuse, misuse or any accessories or parts not supplied by WYBRON, INC. Warranty does not cover "consumable" parts such as fuses, lamps, or color media. WYBRON INC.'s warranty does not extend to items not manufactured by us. Freight terms on warranty repairs are FOB WYBRON, INC. factory or designated repair facility. Collect shipments or freight allowances will not be accepted.

WYBRON, INC.'s sole responsibility under this warranty shall be to repair or replace at WYBRON, INC.'s option such parts as shall be determined to be defected on WYBRON, INC.'s inspection. WYBRON, INC. will not assume any responsibility for any labor expended or materials used to repair any equipment without WYBRON, INC.'s prior written authorization.

WYBRON, INC. shall not be responsible for any incidental, general or consequential damages to property, damages for loss of use, time, profits or income, or any other charges. The owner's obligations during the warranty period under this warranty are to notify WYBRON, INC. at WYBRON, INC.'s address within one week of any suspected defect, and return the goods prepaid to WYBRON, INC. at their factory or authorized service center.

This warranty is contingent on the customer's full and timely compliance with the terms of payment set forth in said purchase order. This warranty is expressly in lieu of any and all other warranties expressed or implied including the warranties of merchantability and fitness for a particular purpose and of other obligations and liabilities on our part. The owner acknowledges that no other representations were made to him or relied upon him with respect to the quality and function of the goods sold.

This written warranty is intended as a complete and exclusive statement of the terms thereof. Prior dealings or trade usage shall not be relevant to modify, explain or vary this warranty. Acceptance of, or acquiescing in, a course of performance under this warranty shall not modify the meaning of this agreement even though either party has knowledge of the performance and a chance to object.



